

Article number: 6160404040

Description: Welding hub for taper bush type MSB
for taper bush 4040

Measures

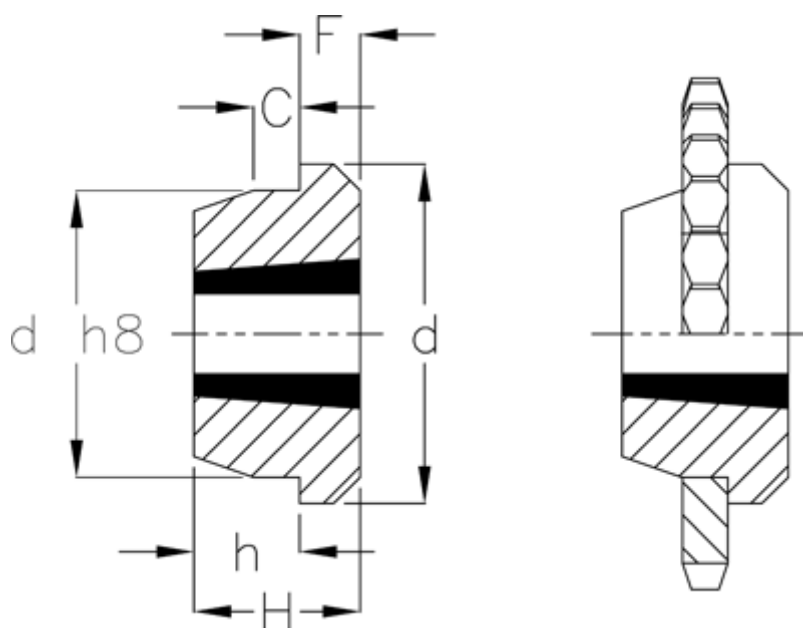

C	= 35
d	= 225
d H8	= 195
F	= 32
For taper bush	= 4040
H	= 102
h	= 70